

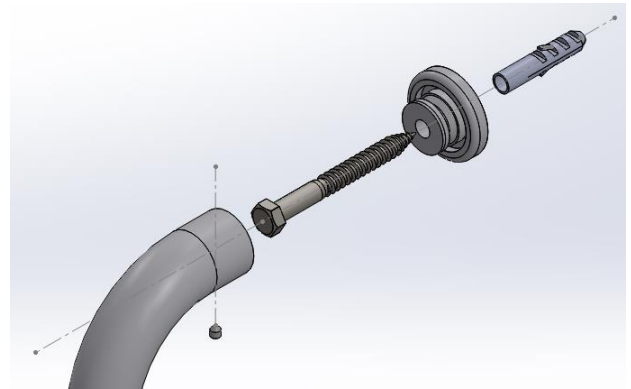

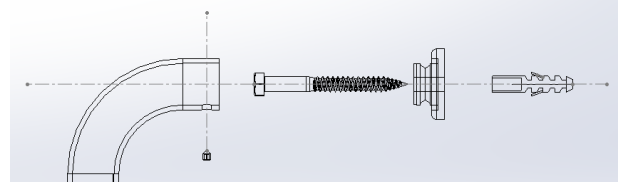
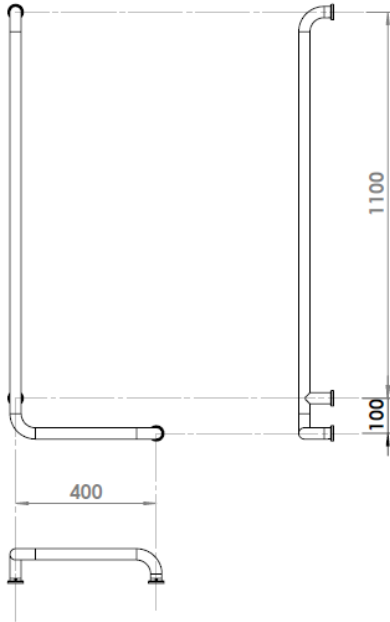

ASENNUSOHJE

SL-1245 "GAISSA"

INST-002

SUIHKUTUKIKAIDE

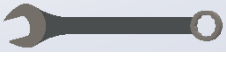
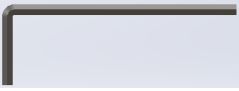

Tarvike	Määrä	Kuvaus
	3	ZN, 8x70mm
	3	10X70mm
		Ø 10mm
		13mm
		3mm

ASENNUSOHJE

SL-1245 "GAISSA"

INST-002

SUIHKUTUKIKAIDE

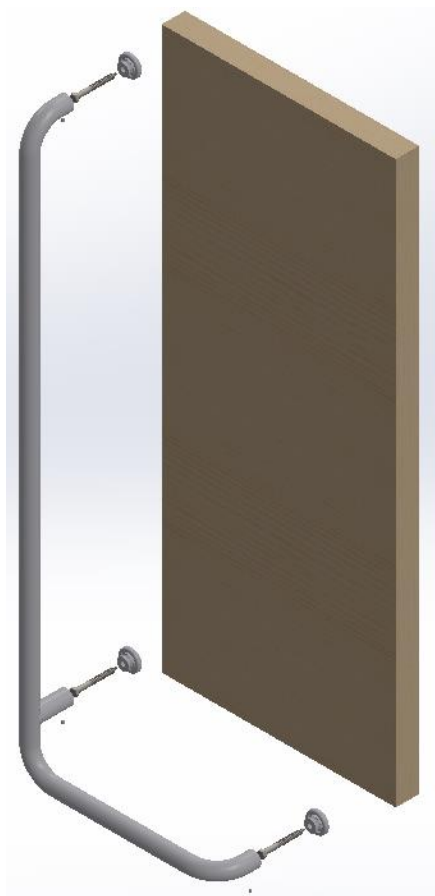

Tarvike	Määrä	Kuvaus
	3	ZN, 8x70mm
		Ø 5mm
		13mm
		3mm